

# KATANA<sup>®</sup>

**BRUSHLESS**  
PERFORMANCE MOTOR

## CORDLESS BRUSHLESS CHAINSAW INSTRUCTION MANUAL

*2x 18V CHARGE-ALL*

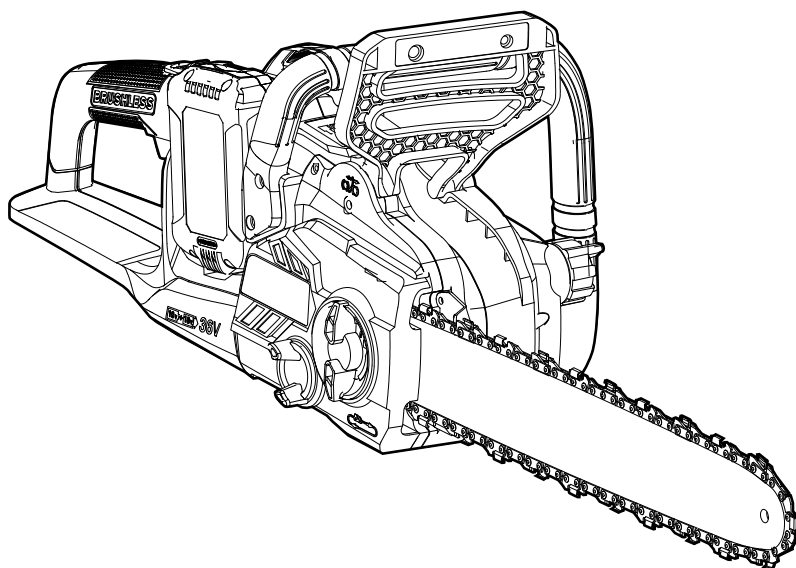

04/22

**5 YEAR  
WARRANTY\***

**2x 18V  
LITHIUM ION**

220231

## GENERAL POWER TOOL SAFETY WARNINGS

220231

**WARNING** Read all safety warnings and all instructions.

Failure to follow the warnings and instructions may result in electric shock, fire and/or serious injury.

Save all warnings and instructions for future reference.

The term "power tool" in the warnings refers to your mains-operated (corded) power tool or battery-operated (cordless) power tool.

**1) Work area safety**

- a) **Keep work area clean and well lit.**  
*Cluttered or dark areas invite accidents.*
- b) **Do not operate power tools in explosive atmospheres, such as in the presence of flammable liquids, gases or dust.** *Power tools create sparks which may ignite the dust or fumes.*
- c) **Keep children and bystanders away while operating a power tool.** *Distractions can cause you to lose control.*

**2) Electrical safety**

- a) **Power tool plugs must match the outlet. Never modify the plug in any way. Do not use any adapter plugs with earthed (grounded) power tools.** *Unmodified plugs and matching outlets will reduce risk of electric shock.*
- b) **Avoid body contact with earthed or grounded surfaces, such as pipes, radiators, ranges and refrigerators.** *There is an increased risk of electric shock if your body is earthed or grounded.*
- c) **Do not expose power tools to rain or wet conditions.** *Water entering a power tool will increase the risk of electric shock.*
- d) **Do not abuse the cord. Never use the cord for carrying, pulling or unplugging the power tool. Keep cord away from heat, oil, sharp edges or moving parts.** *Damaged or entangled cords increase the risk of electric shock.*
- e) **When operating a power tool outdoors, use an extension cord suitable for outdoor use.** *Use of a cord suitable for outdoor use reduces the risk of electric shock.*
- f) **If operating a power tool in a damp location is unavoidable, use a residual current device (RCD) protected supply.** *Use of an RCD reduces the risk of electric shock.*

**3) Personal safety**

- a) **Stay alert, watch what you are doing and use common sense when operating a power tool. Do not use a power tool while you are tired or under the influence of drugs, alcohol or medication.** *A moment of inattention while operating power tools may result in serious personal injury.*
- b) **Use personal protective equipment. Always wear eye protection.** *Protective equipment such as dust mask, non-skid safety shoes, hard hat, or hearing protection used for appropriate conditions will reduce personal injuries.*
- c) **Prevent unintentional starting. Ensure the switch is in the off-position before connecting to power source and/or battery pack, picking up or carrying the tool.** *Carrying power tools with your finger on the switch or energising power tools that have the switch on invites accidents.*
- d) **Remove any adjusting key or wrench before turning the power tool on.** *A wrench or a key left attached to a rotating part of the power tool may result in personal injury.*
- e) **Do not overreach. Keep proper footing and balance at all times.** *This enables better control of the power tool in unexpected situations.*
- f) **Dress properly. Do not wear loose clothing or jewellery. Keep your hair, clothing and gloves away from moving parts.** *Loose clothes, jewellery or long hair can be caught in moving parts.*

- g) **If devices are provided for the connection of dust extraction and collection facilities, ensure these are connected and properly used.** *Use of dust collection can reduce dust-related hazards.*

**4) Power tool use and care**

- a) **Do not force the power tool. Use the correct power tool for your application.** *The correct power tool will do the job better and safer at the rate for which it was designed.*
- b) **Do not use the power tool if the switch does not turn it on and off.** *Any power tool that cannot be controlled with the switch is dangerous and must be repaired.*
- c) **Disconnect the plug from the power source and/or the battery pack from the power tool before making any adjustments, changing accessories, or storing power tools.** *Such preventive safety measures reduce the risk of starting the power tool accidentally.*
- d) **Store idle power tools out of the reach of children and do not allow persons unfamiliar with the power tool or these instructions to operate the power tool.** *Power tools are dangerous in the hands of untrained users.*
- e) **Maintain power tools. Check for misalignment or binding of moving parts, breakage of parts and any other condition that may affect the power tool's operation. If damaged, have the power tool repaired before use.** *Many accidents are caused by poorly maintained power tools.*
- f) **Keep cutting tools sharp and clean.** *Properly maintained cutting tools with sharp cutting edges are less likely to bind and are easier to control.*
- g) **Use the power tool, accessories and tool bits etc. in accordance with these instructions, taking into account the working conditions and the work to be performed.** *Use of the power tool for operations different from those intended could result in a hazardous situation.*

**5) Battery tool use and care**

- a) **Recharge only with the charger specified by the manufacturer.** *A charger that is suitable for one type of battery pack may create a risk of fire when used with another battery pack.*
- b) **Use power tools only with specifically designated battery packs.** *Use of any other battery packs may create a risk of injury and fire.*
- c) **When battery pack is not in use, keep it away from other metal objects, like paper clips, coins, keys, nails, screws or other small metal objects, that can make a connection from one terminal to another.** *Shorting the battery terminals together may cause burns or a fire.*
- d) **Under abusive conditions, liquid may be ejected from the battery; avoid contact. If contact accidentally occurs, flush with water. If liquid contacts eyes, additionally seek medical help.** *Liquid ejected from the battery may cause irritation or burns.*

**6) Service**

- a) **Have your power tool serviced by a qualified repair person using only identical replacement parts.** *This will ensure that the safety of the power tool is maintained.*

## CHAINSAW SAFETY WARNINGS

220231

- a) Keep all parts of the body away from the saw chain when the chainsaw is operating. Before you start the chainsaw, make sure the saw chain is not contacting anything. A moment of inattention while operating chainsaws may cause entanglement of your clothing or body with the saw chain.
- b) Always hold the chainsaw with your right hand on the rear handle and your left hand on the front handle. Holding the chainsaw with a reversed hand configuration increases the risk of personal injury and should never be done.
- c) Hold the product by insulated gripping surfaces only, because the saw chain may contact hidden wiring. Saw chains contacting a "live" wire may make exposed metal parts of the product "live" and could give the operator an electric shock.
- d) Wear safety glasses and hearing protection. Further protective equipment for head, hands, legs and feet is recommended. Adequate protective clothing will reduce personal injury by flying debris or accidental contact with the saw chain.
- e) Do not operate a chainsaw in a tree. Operation of a chainsaw while up in a tree may result in personal injury.
- f) Always keep proper footing and operate the chainsaw only when standing on fixed, secure and level surface. Slippery or unstable surfaces such as ladders may cause a loss of balance or control of the chainsaw.
- g) When cutting a limb that is under tension be alert for spring back. When the tension in the wood fibers is released the spring loaded limb may strike the operator and/or throw the chainsaw out of control.
- h) Use extreme caution when cutting brush and saplings. The slender material may catch the saw chain and be whipped toward you or pull you off balance.
- i) Carry the chainsaw by the front handle with the chainsaw switched off and away from your body. When transporting or storing the chainsaw always fit the guide bar cover. Proper handling of the chainsaw will reduce the likelihood of accidental contact with the moving saw chain.
- j) Follow instructions for lubricating, chain tensioning and changing accessories. Improperly tensioned or lubricated chain may either break or increase the chance for kickback.
- k) Keep handles dry, clean, and free from oil and grease. Greasy, oily handles are slippery causing loss of control.
- l) Cut wood only. Do not use chainsaw for purposes not intended. For example: do not use chainsaw for cutting plastic, masonry or non-wood building materials. Use of the chainsaw for operations different than intended could result in a hazardous situation.
- m) Before starting work, check that the chain saw is in proper working order and that its condition complies with the safety regulations.
  - The chain brake is working properly;
  - The run-down brake is working properly;
  - The bar and the sprocket cover are fitted correctly;
  - The chain has been sharpened and tensioned in accordance with the regulations.
- 7) Personal protective equipment  
 Good quality, personal protective equipment as used by professionals will help to reduce the risk of injury to the operator. The following items should be used when operating the product:
  - Safety helmet
  - Hearing protection
  - Eye and face protection
  - Gloves
  - Leg protection (chaps)
  - Chainsaw safety boots
  - Chainsaw jackets for upper body protection

## 8) Causes And Operator Prevention Of Kickback

Kickback may occur when the nose or tip of the guide bar touches an object, or when the wood closes in and pinches the saw chain in the cut.

Tip contact in some cases may cause a sudden reverse reaction, kicking the guide bar up and back towards the operator.

Pinching the saw chain along the top of the guide bar may push the guide bar rapidly back towards the operator. Either of these reactions may cause you to lose control of the saw which could result in serious personal injury. Do not rely exclusively upon the safety devices built into your saw. As a chainsaw user, you should take several steps to keep your cutting jobs free from accident or injury.

Kickback is the result of tool misuse and/or incorrect operating procedures or conditions and can be avoided by taking proper precautions as given below:

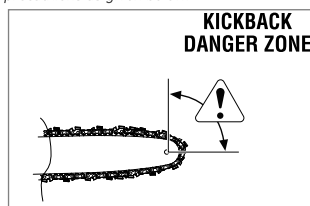

- a) Maintain a firm grip, with thumbs and fingers encircling the chainsaw handles, with both hands on the saw and position your body and arm to allow you to resist kickback forces. Kickback forces can be controlled by the operator, if proper precautions are taken. Do not let go of the chainsaw.
- b) Do not overreach and do not cut above shoulder height. This helps prevent unintended tip contact and enables better control of the chainsaw in unexpected situations.
- c) Only use replacement bars and chains specified by the manufacturer. Incorrect replacement bars and chains may cause chain breakage and/or kickback.
- d) Follow the manufacturer's sharpening and maintenance instructions for the saw chain. Decreasing the depth gauge height can lead to increased kickback.
- 9) Additional Chainsaw Safety Warnings
- a) It is recommended to cut logs on a saw-horse or cradle when operating the product the first time.
- b) Ensure all guards, handles and spiked bumper are properly fitted and are in good condition.
- c) Persons using this chainsaw should be in good health. The chainsaw is a heavy unit so the operator requires to be physically fit. The operator should be alert, have good vision, mobility, balance and manual dexterity. If there is any doubt, do not operate the chainsaw.
- d) Do not start using the product until you have a clear work area, secure footing, and a planned retreat path away from the falling tree.
- e) Beware of the emission of lubricant mist and saw dust. Wear a mask or respirator if required. Do not cut vines and/or small undergrowth (less than 75 mm in diameter).
- f) Always hold the chainsaw with both hands when operating the saw. Use a firm grip with thumbs and fingers encircling the chainsaw handles. Right hand must be on the rear handle and left hand on the front handle.
- g) Before starting the tool, make sure the saw chain is not contacting any object.
- h) Do not modify your tool in any way or use it to power any attachments or devices not recommended by the manufacturer for your saw.

## CHAINSAW SAFETY WARNINGS

220231

- i) *There should be a first-aid kit containing large wound dressings and a means to summon attention (e.g., whistle) close to the operator. A larger more comprehensive kit should be reasonably nearby. The operator may be tempted to remove the helmet if there is no danger of falling objects in the work area, but remember the helmet, particularly with the mesh visor, can help reduce the potential for injury to the face and head if kickback occurs.*
- j) *An incorrectly tensioned chain can jump off the guide bar and could result in serious injury or fatality. The length of chain depends on the temperature of the chain and chain wear. Check the tension frequently.*
- k) *You should get used to your new chainsaw by making simple cuts on securely supported wood. Do this whenever you have not operated the saw for some time.*
- l) *To reduce the risk of injury associated with contacting moving parts, always stop the motor, apply chain brake, remove the battery pack and make sure all moving parts have come to a stop before:
 
  - cleaning or clearing a blockage
  - leaving the product unattended
  - installing or removing attachments
  - checking, maintenance or working on the machine*
- m) *The size of the work area depends on the job being performed as well as the size of the tree or work piece involved. For example, felling a tree requires a larger work area than making other cuts, i.e., bucking cuts, etc. The operator needs to be aware and in control of everything happening in this work area.*
- n) *Do not cut with your body in line with the guide bar and chain. If you do experience kickback this will help prevent the chain coming into contact with your head or body.*
- o) *Do not use a back and forward sawing motion, let the chain do the work, keep the chain sharp and don't try to push the chain through the cut.*
- p) *Do not put pressure on the saw at the end of the cut. Be ready to take on the weight of the saw as it cuts free from the wood. Failure to do so could result in possible serious personal injury.*
- q) *Do not stop the saw in the middle of a cutting operation. Keep the saw running until it is already removed from the cut.*

### Guide bars

Generally, guide bars with small radius tips have somewhat lower potential for kickback. Use a guide bar and matching chain that is just long enough for the job. Longer bars increase the risk of loss of control during sawing. Regularly check the chain tension. When cutting smaller branches (less than the full length of the guide bar), the chain is more likely to be thrown off if the tension is not correct.

### Chain brake

Chain brakes are designed to quickly stop the chain rotating. When the chain brake lever/hand guard is pushed towards the bar, the chain should stop immediately. A chain brake does not prevent kickback. It only lowers the risk of injury should the chain bar contact the operator's body during a kickback event. The chain brake should be tested before each use for correct operation in both the run and brake positions.

### Overload protection

When the tool is operated in a manner that causes it to draw an abnormally high current, the tool automatically stops and the main power lamp will blink. In this situation, turn the tool off and stop the application that caused the tool to become overloaded. The ON/OFF button will be required to be re-pressed resume operation.



## SAFETY DEVICES

### Low kickback saw chain

A low-kick-back saw chain helps to reduce the possibility of a kickback event.

The rakers (depth gauges) ahead of each cutter can minimize the force of a kickback reaction by preventing the cutters from digging in too deeply. Use only replacement guide bar and chain combinations that are recommended by the manufacturer.

As saw chains are sharpened, they lose some of the low kickback qualities and extra caution is required. For your safety, replace saw chains when cutting performance decreases.

### Spiked bumper

The integral bucking spike may be used as a pivot when making a cut. It helps to keep the body of the chainsaw steady while cutting. When cutting, push the machine forward until the spikes dig into the edge of the wood, then move the rear handle up or down in the direction of the cutting line. This method helps ease the physical strain of cutting.

**KNOW YOUR PRODUCT**

220231

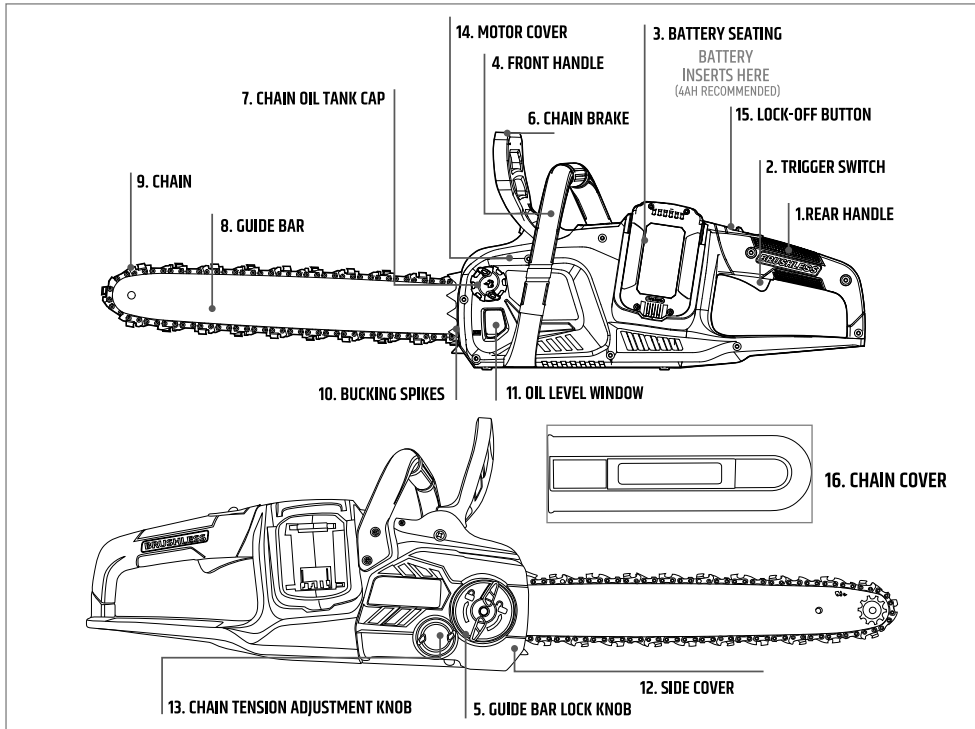

**SPECIFICATIONS**

Voltage	36V d.c. (2 x 18 Volt)	Chain Speed	15m/s
Cutting Width	395mm	Max No. Load Speed	8,000rpm
Stop Time	<0.12 Second	Oil Tank Capacity	180ml
Bar Length	16"	Weight	3.7kg

**HOW TO INSERT BATTERIES ON TOOL (MINIMUM 4AH RECOMMENDED)**

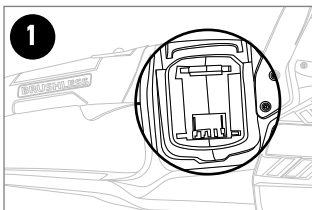

**1. ALIGN BATTERY RIBS WITH TOOL**

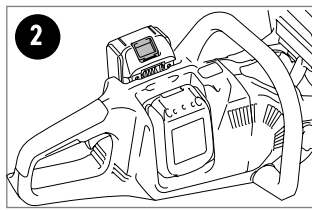

**2. MAKE SURE BOTH BATTERIES ARE INSERTED**

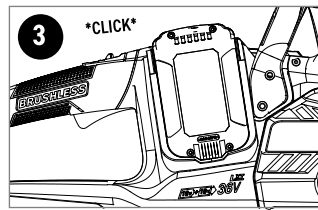

**3. SLIDE INTO TOOL & STOP WHEN YOU HEAR IT CLICK IN**

**HOW TO ASSEMBLY THE CHAINSAW**

220231

**⚠ WARNING DO NOT EXPOSE TO RAIN OR DAMP CONDITIONS**



**1. ENSURE SAFETY**

Always wear safety glasses, gloves & safety boots when working with the chainsaw. Make sure to secure your hair and any baggy clothes. In appropriate situations make sure you wear ear muffs, a mask or a respiratory mask.

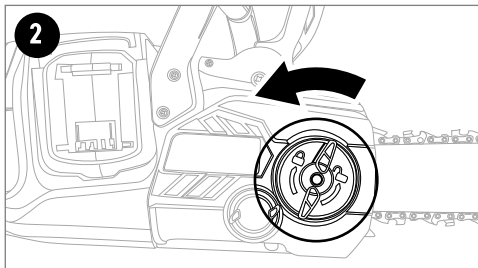

**2. UNSCREW GUIDE BAR LOCK KNOB**

Completely unscrew the guide bar lock knob, in an anti clockwise direction.

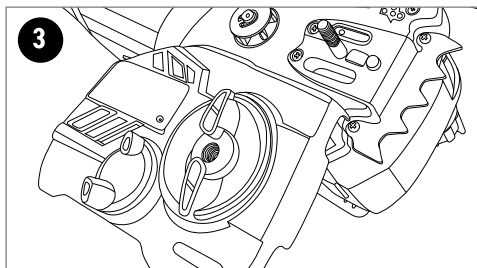

**3. REMOVE COVER**

Remove the side cover.

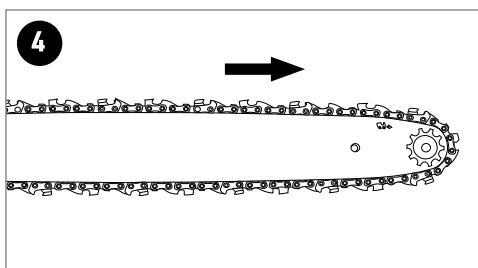

**4. FIT THE CHAIN**

Fit the chain over the guide bar making sure that the cutters are facing in the direction of rotation.

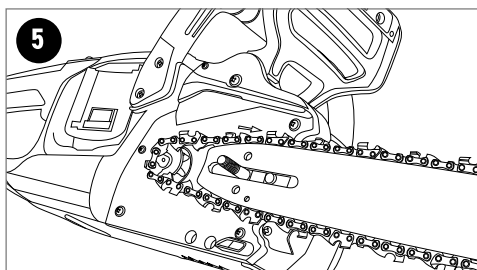

**5. POSITION CHAIN AND GUIDE BAR**

Place the guide bar and chain in position, ensuring that the chain is around sprocket wheel. Also ensure that the threaded pin fits into the guide bar tension dial. If it does not fit, it can be adjusted slightly by turning the dial.

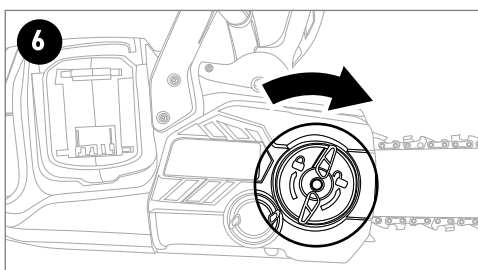

**6. TIGHTEN GUIDE BAR LOCK KNOB**

Attach the side cover and secure it with the side cover lock. Do not fully tighten the guide bar lock knob after adjusting the chain tension.

## HOW TO ASSEMBLY THE CHAINSAW

220231



### WARNING

Always remove the battery when you leave the chainsaw unattended and making any adjustments or performing maintenance to the chainsaw  
Never adjust the chain when it is hot, the chain will shrink slightly when it cools.

### ADJUSTING CHAIN TENSION

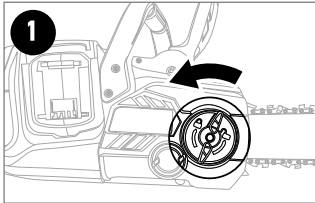

#### 1. LOOSEN GUIDE BAR LOCK KNOB

Loosen the guide bar lock knob slightly, by rotating it in an anti-clockwise direction.

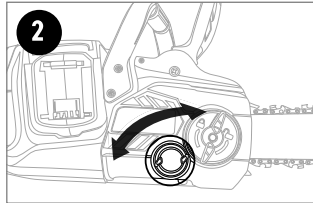

#### 2. ADJUST TENSION KNOB

Adjust the chain tension by using the tensioning adjustment knob. The dial clockwise increases the chain tension, turning it anti clockwise decreases the chain tension.

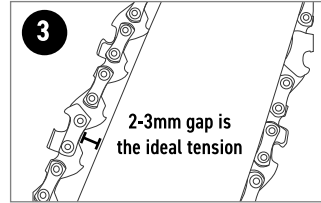

#### 3. CORRECT TENSION

For the correct chain tension, firmly pull up on the chain at the middle of the top of the exposed guide bar. When the chain is pulled up to its highest point, the bottom tip of the links should only just stay in the track (middle of the guide bar).

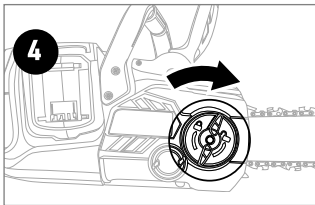

#### 4. TIGHTEN GUIDE BAR LOCK KNOB

After the chain has been accurately tensioned, lock the guide bar in place with the guide bar lock knob.

It is important the chain is tensioned correctly for proper safety operation.

### OIL THE SAW CHAIN

#### IMPORTANT

- ONLY USE OIL THAT IS CLEARLY LABELED "CHAIN BAR OIL"
- NEVER START WORK UNLESS THE CHAIN AND BAR ARE LUBRICATED

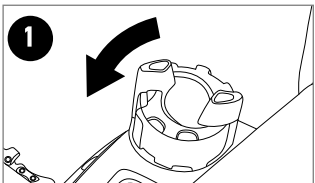

#### 1. REMOVE OIL CAP

Remove the chain bar oil cap.

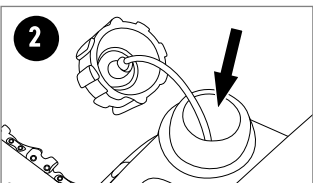

#### 2. FILL TANK

Fill the tank with chain bar oil. The capacity of the chain oil tank is 180ml. Do not over fill.

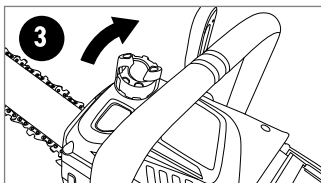

#### 3. REFIT OIL CAP

Refit cap and clean any oil spillage. Always fill the oil tank when the oil level is below the minimum.

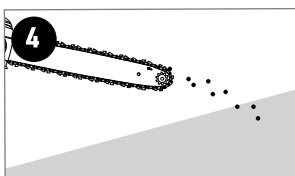

#### 4. CHECK SYSTEM

To check the lubricating system, switch on the chainsaw and hold it with the guide bar and chain above some light coloured paper such as newspaper. A steadily increasing stain caused by oil spray shows the lubricating system is working.

**Note:** Chain bar oil may leak if the tool is left for long periods. This is normal. If the tool is to be left unused for an extended time, drain the oil from the tool. Refill before use.

## OPERATION

220231

### TURNING ON THE CHAINSAW

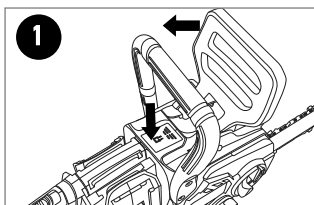

1. Pull the hand guard/chain brake towards you and press the ON/OFF button.

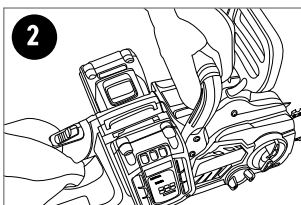

2. Hold the front handle with your left hand and the rear handle with your right hand.

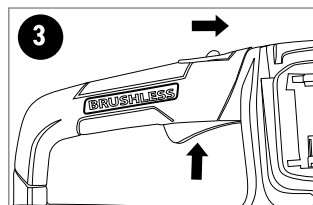

3. Slide forward and hold the lock-off button with your thumb, then squeeze the trigger switch. The chainsaw starts after a short delay.

The chain will now be running ready to make a cut. Release the lock-off switch.

### TURNING OFF THE CHAINSAW

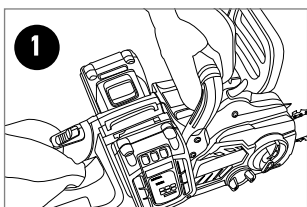

1. Release the trigger switch, the chain and motor will quickly stop.

### CHAIN BRAKE

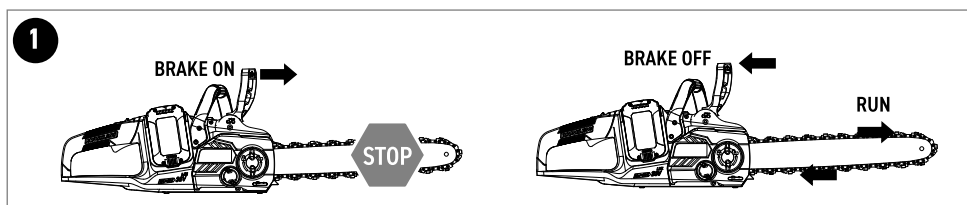

The chain brake operates automatically in the event of kick back.

The chainsaw is fitted with a hand guard/chain brake which when operated brings the chain to a stop within a tenth of a second.

The chain brake can be operated manually by pushing it forward or automatically as a result of kickback.

Kickback occurs if the chain catches on the wood being cut and the chainsaw recoils back suddenly.

In the event of kickback, your hand (which is on the front handle during operation) jerks forward causing the back on your hand to push the guard forward, engaging the chain brake and quickly stopping the chain.



**OPERATION**

220231

**CUTTING**

**CAUTION** FIRST TIME USERS SHOULD, AS A MINIMUM PRACTICE, CUT LOGS ON A SAW-HORSE OR CRADLE

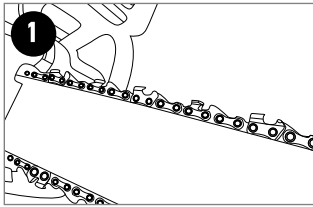

1. Press the bucking spikes against the timber ensuring the chain is not making contact with the material being cut.

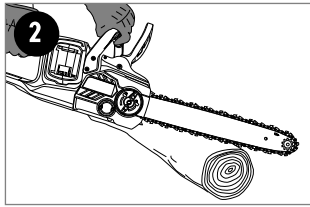

2. Start cutting by holding the chainsaw by the front handle and raising the rear handle.

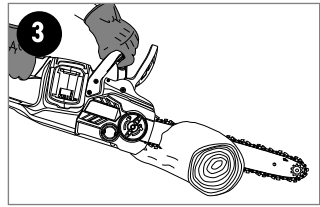

3. If you cannot cut the timber in a single stroke, apply light pressure to the front handle and continue sawing, draw the chainsaw back a little then apply the bucking spikes a little lower and finish the cut by raising the rear handle.

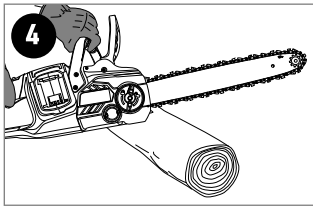

4. Withdraw the chainsaw from the cut while the chain is still running.

**HINTS AND TIPS**

- Do not force the saw into the cut. Apply only light pressure whilst running the chain.
- If the saw chain gets caught in the cut, do not try to remove it by twisting the guide bar or pulling forcibly. Use a lever or wedge to open up the cut so that the saw chain is freed.
- Keep your left arm with elbow locked in a "straight arm" position to withstand any kickback force.

**While cutting always:**

- Run the chainsaw motor at full speed. This makes the job safer, as there is less chance of pull-in or kick-back.
- Position your body to the left of the chainsaw so if it kicks back uncontrollably, it goes over your right shoulder, never stand in the cutting line of the saw.
- Keep a firm grip with your left hand on the front handle with your thumb securely below the handle.

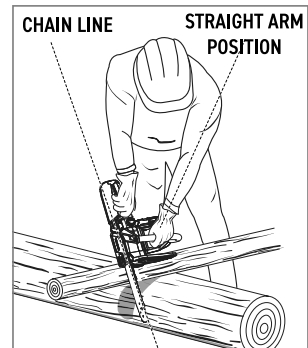

**OPERATION**

**220231**

 **WARNING** FELLING A TREE SHOULD ONLY BE COMPLETED BY TRAINED OPERATORS. ONLY PERSONS INVOLVED IN THE FELLING OPERATION SHOULD BE IN THE VICINITY.

 **WARNING** AN ESCAPE PATH SHOULD BE PLANNED AND CLEARED AS NECESSARY BEFORE CUTS ARE STARTED. THE ESCAPE PATH SHOULD EXTEND BACK AND DIAGONALLY TO THE REAR OF THE EXPECTED LINE OF FALL.

 **WARNING** DO NOT FELL TREES DURING PERIODS OF HIGH WIND OR HEAVY PRECIPITATION.

**FELLING A TREE**

Decide the direction in which you wish the tree to fall, taking into account the direction of the wind, the position of branches, lean of the tree, ease of subsequent limbing and bucking and other factors prevalent at the time.

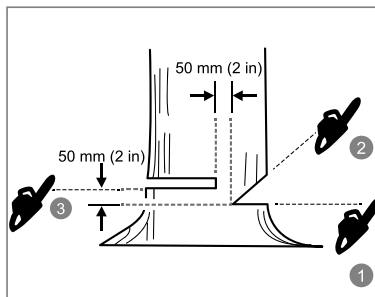

**PLAN AN ESCAPE PATH**

Plan and clear an escape path before cuts are starting cuts. The escape path should extend back and diagonally to the rear of the expected line of fall.

Before starting to fell a tree, consider the natural lean of the tree, the location of larger branches and the wind direction to judge which way the tree will fall.

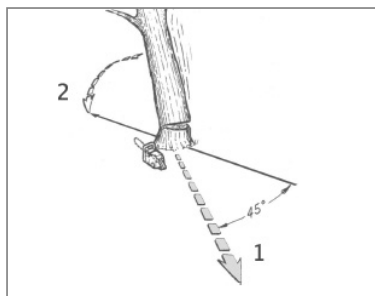

 **WARNING** FELLING ALWAYS KEEP A BALANCED STANCE. DO NOT STAND ON THE LOG. BE ALERT TO THE FACT THAT THE LOG MAY ROLL OVER. WHEN WORKING ON A SLOPE, ALWAYS STAND ON THE UP HILL SIDE OF THE LOG.

## OPERATION

220231

### LIMBING

Limbing is the process of removing the branches from a fallen tree. Check the direction in which a branch will bend before cutting it. Always cut on the opposite side to the bending direction so that the guide bar is not pinched in the cut.

For large limbs that cannot be removed in one cut, make an initial cut from the bent side and finish by sawing from the opposite direction. Do not remove limbs that are supporting the fallen tree on the ground until the tree has been cut into lengths.

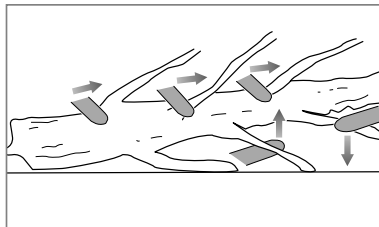

### BUCKING

Bucking is cutting a log into lengths for easier handling. To saw a log lying on the ground, first saw halfway, then roll the log over and cut from the opposite side. To saw the end of a log supported off the ground, first saw up from the bottom one-third through the log then finish by sawing down from the top. To saw a log in the middle of two supports holding it off the ground, first saw down from the top one-third through the log then finish by sawing up from the bottom.

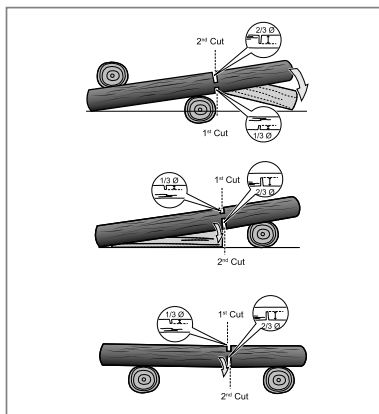

### CAUTION

**AVOID CUTTING THE GROUND AS THIS WILL VERY QUICKLY DULL THE SAW CHAIN.**



### WARNING

**DO NOT USE AN UNSTABLE FOOTHOLD OR LADDER. DO NOT OVERREACH. DO NOT SAW ABOVE SHOULDER HEIGHT. ALWAYS USE BOTH HANDS TO HOLD THE SAW. FIRST CUT UP FROM THE BOTTOM AND FINISH DOWN FROM THE TOP.**

### PRUNING

Pruning is the removal of a limb or branch from a standing tree. First cut up from the bottom one-third through the limb or branch then finish by sawing down from the top. This is the required method to reduce the risk of the chainsaw getting stuck in the branch or resulting in the operator coming unbalanced.

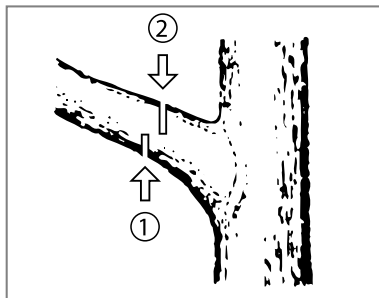

## MAINTENANCE

220231



### WARNING

**BEFORE CLEANING YOUR CHAINSAW OR CARRYING OUT ANY MAINTENANCE PROCEDURE, MAKE SURE THE BATTERY IS REMOVED TO PREVENT ACCIDENTAL STARTING.**

### CAUTION

**ALWAYS WEAR GLOVES WHEN HANDLING THE CHAIN AS IT IS VERY SHARP AND CAN CAUSE INJURY YOU WHEN IT IS NOT MOVING.**

## MAINTAINING THE GUIDE BAR

1. Remove any sawdust from the guide bar, including the groove.  
Oil and sawdust combine and emit a burning smell during operation if the blade is not regularly cleaned.
2. Make sure that the oil port is not clogged. Grease the nose sprocket at the tip of the guide bar.
3. Check for oil leakage and loose fastenings, especially those securing the handles and the guide bar.
4. Reverse the guide bar every 8 working hours to ensure uniform wear.  
Check the guide rails frequently and if necessary remove burrs and square up the rails using a flat file.

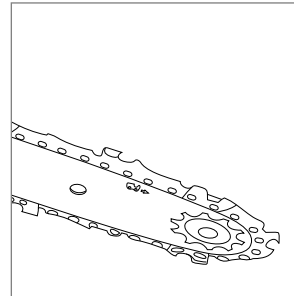

## CHAIN SHARPENING

Chain File: 3.96mm (5/32")

Chain Pitch: 9.53mm (3/8")

Chain Gauge: 1.1mm (0.043")

Sharpen the chain regularly to maintain optimum performance of the saw.

### Signs of a dull chain are:

- The sawdust becomes powder-like
- Extra force is required to execute a cut
- The cut does not track in a straight line
- Increased vibration / heat burn

Sharpen each cutter using a round 3.96mm (5/32") chain file. Keep the file level with the top plate of the tooth. Always use outward strokes and maintain a 30° angle between the chain and file. After sharpening, the cutters must all have the same width and length. After every 3–4 uses get an authorized repair center to professionally sharpen your chain. They have the special tools necessary to ensure the correct cutting angles and depths.

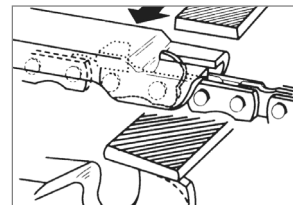
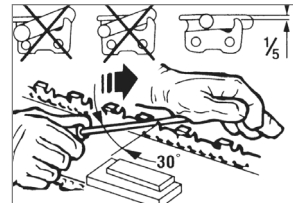

## CLEANING AND STORING

- Keep the handles free of grease so that you can maintain a firm grip.
- Clean the device as required with a damp cloth and, if necessary, mild washing up liquid.
- If the chainsaw is not to be used for an extended period of time then you should remove the chain oil from the tank.  
Briefly immerse the chain and the cutter rail in an oil bath and then wrap them in oil paper.
- Ensure that the guide bar cover is in place when storing.

### CAUTION

**ALWAYS DISCONNECT BOTH BATTERIES BEFORE CLEANING THE CHAINSAW. NEVER IMMERSE THE UNIT IN WATER OR OTHER LIQUIDS IN ORDER TO CLEAN IT. STORE THE CHAINSAW IN A SAFE AND DRY PLACE OUT OF THE REACH OF CHILDREN.**

## TROUBLESHOOTING















220231

Problem	Cause	Remedy
Chainsaw will not work	Chain brake engaged	Disengage brake
	Batteries are low in charge	Charge both batteries
	Battery not inserted properly	Insert battery packs correctly
	Over load protection activated	Press the ON/OFF button to reset the overload protection.
Dry chain	No oil in oil tank	Fill oil tank with chain bar oil
	Oil tank cap breather blocked	Clean oil tank cap
	Oil outlet blocked	Clear oil outlet
Chain or guide rail hot	No oil in oil tank	Fill oil tank with chain bar oil
	Oil tank cap breather blocked	Clean oil tank cap
	Oil outlet blocked	Clear oil outlet
	Blunt chain	Sharpen or replace chain
Wont cut	Blunt chain	Sharpen or replace chain
	Chain on backwards (chain teeth pointing in the wrong direction)	Remove chain and reinstall with the teeth facing in the correct direction
	Worn chain	Replace the chain
Chainsaw vibrating or not cutting properly	Chain tension too loose	Adjust chain to correct tension
	Blunt chain	Sharpen or replace chain
	Worn chain	Replace the chain
	Chain on backwards (chain teeth pointing in the wrong direction)	Remove chain and reinstall with the teeth facing in the correct direction

## SYMBOLS

220231

The rating plate on your tool may show symbols. These represent important information about the product or instructions on its use.

	Direct current, DC		Waste electrical products should not be disposed of with household waste. Please recycle where facilities exist. Check with your Local Authority or retailer for recycling advice.
	Refer to instruction manual/booklet		
	Wear ear protection		General warning
	Wear eye protection		Regulator compliance mark
	Use appropriate protection for foot-leg and hand-arm.		Direction of chain travel
	Hold and operate the saw properly with both hands.		Beware of chain saw kickback and avoid contact with bar tip.
	Do not operate the saw using only one hand.		
	Remove the battery pack before starting any work on the product.	III	CLASS 3: Battery product



# KATANA®

## Australia & Global

[www.katanapowertools.com.au](http://www.katanapowertools.com.au)

[enquiries@katanapowertools.com.au](mailto:enquiries@katanapowertools.com.au)

+61 3 9730 7100

Made to Katana specifications and quality standards in China.

NOT INTENDED  
FOR TRADE USE

**5 YEAR  
WARRANTY\***

\* All Katana power tools come with a 5 year (3+2 year) replacement warranty from date of purchase.

3 year standard warranty with the option to register your product online at [www.katanapowertools.com.au/register](http://www.katanapowertools.com.au/register) to receive an additional 2 years free of charge.

Products must be registered within 30 days from date of purchase to qualify for warranty extension.

Kincrome guarantees Katana products against faulty workmanship and materials. Kincrome will, at their discretion replace faulty products free of charge. This guarantee does not cover product that has been altered, misused, abused, subjected to normal wear and tear, used for commercial or trade use or not used in accordance with product guidelines.

Warranty is given by Kincrome Australia Pty Ltd of 3 Lakeview Drive, Caribbean Park, Scoresby, Victoria (Tel 1300 657 528). If this product has materials or workmanship defects (other than defects caused by abnormal or non-warranted use) you can, at your cost, send the product to the above address for replacement. Your rights under this warranty are in addition to any other rights you have under the Australian Consumer Law or other applicable laws. Kincrome goods come with guarantees that cannot be excluded under the Australian Consumer Law. You are entitled to a replacement or refund for a major failure.