

Makita

36V (18Vx2) Brushless Multi-Function Power Head

DUX60

18Vx2 18V + 18V 36V
BRUSHLESS

Makita[®]

18Vx2 18V+18V 36V

BRUSHLESS **WHEN POWER MEANS BUSINESS**

When you choose Makita Outdoor Power Equipment, you choose to be part of something bigger. Our complete line up of cordless outdoor solutions will revolutionise the way you work - empowering you with over a century of knowledge and expertise in crafting the world's most reliable tools. With the support of the world's largest 18V cordless system featuring over LXT tools, you can be sure our outdoor equipment will get the job done and more - no petrol or cord needed.



Product Objectives

- Designed to suit the needs of landscapers.
- Develop a 36V (18Vx2) Multi- function power head that is suitable with a range of current attachments.



Product Overview

Active Feedback Technology

3 Speed Selection and variable trigger

Loop Handle of optimum control

Quick transitions between attachments



Ergonomically positioned trigger



Product Specification Sheet



- **36V (18Vx2)** – powered by two 18V Li-ion batteries the Multi-function power head is supplied with 36V of power to the brushless motor
- **XPT** – for use in outdoor applications protection from dust and dripping water is enhanced protecting the circuitry
- **Brushless Motor** – the DUX60Z possesses the Makita BL 52 motor providing high levels of performance
- **Quick transition between Attachments** – a simple to operate lever and button system allows quick changing of attachments
- **Active Feedback Technology**– If the sensor detects a drastic decrease in the rotation of the attachment the motor will stop immediately
- **3 Speed Selection and variable trigger**- Variable speed control by trigger along with 3 set speeds allows flexible depending on the attachment being used

Voltage		36V (18Vx2)
Max output power: W		600
No load speed: rpm	High	9,700
	Medium	8,200
	Low	5,700
Grass clipping removal function		Yes
Variable Speed Control		Yes
Weight:		5.6kg

Advantages

Performance

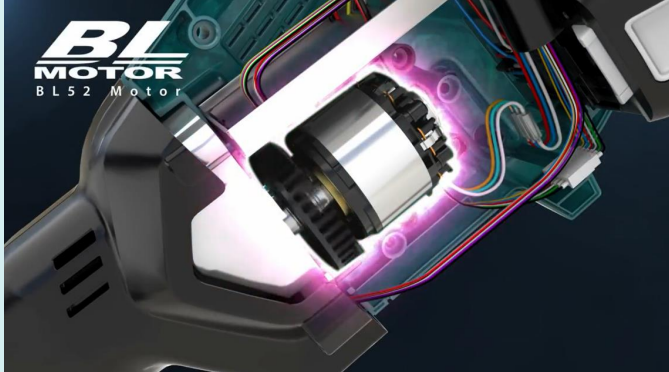

Motor delivering high levels of performance

Innovation



Unbelievable performance thanks to 36V (18Vx2) technology

Convenience



Quick transitions between attachments

Ergonomics



Loop handle with low vibrations

Advantages

Makita's high performance Brushless DC motor

The BL Brushless Motor produces longer run time than brushed motors. Allows the motor to achieve a higher rpm, due to no friction lost between brush and commutator. It's also more durable as there are no carbon brushes to change.

Teamed together with Makita's 36V (18Vx2) technology two 18V Li-ion batteries can be installed directly to the unit to supply power to the motor.

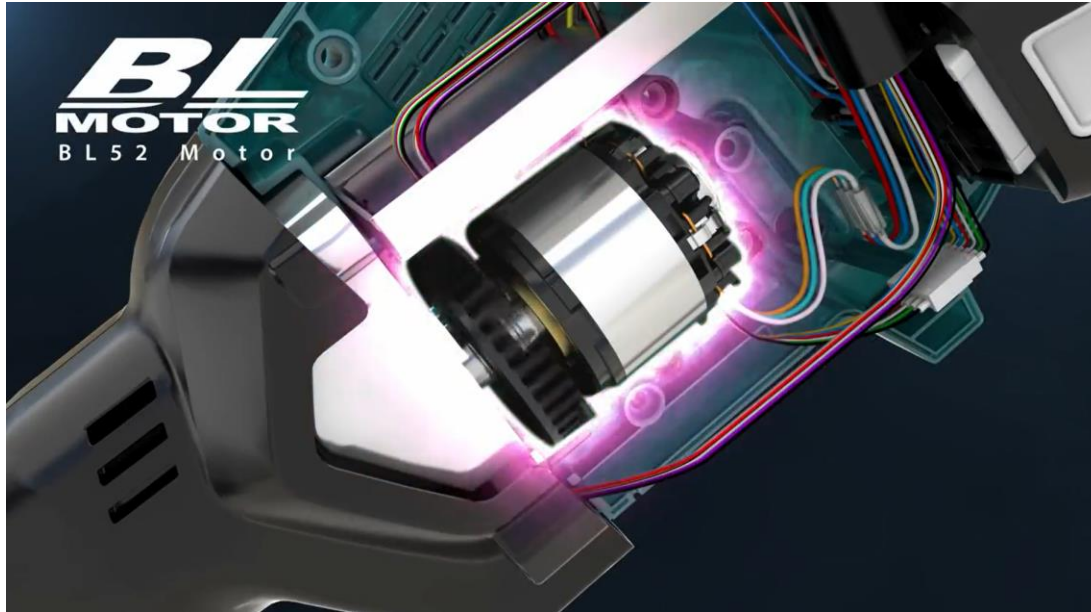

Advantages







Active Feedback Technology

If the sensor detects a drastic decrease in the rotation of the attachment the motor will stop immediately.

If kickback occurs while using the pole saw attachment, the brake will automatically switch on.







Attachments

Brushcutter	Pole Saw	Ground Trimmer	Pole Hedge Trimmer	Edger	Cultivator	Extension
						
EM401MP	EY401MP	EN420MP	EN401MP	EE400MP	KR400MP	LE400MP (Length: 1,080mm)
195951-1	196104-5	198057-4	196340-3	196750-4	195712-9	196031-6

*Please note: For safety reasons 196073-0 is not suitable for use with DUX60Z

Accessories

Standard Accessories		
	125516-5	Band Assembly
	783202-0	Hex Wrench 4
	831304-7	Accessory Bag

Optional Accessories		
	BL1815N BL1830B BL1840B BL1850B BL1860B	Batteries 18V Li-Ion – 1.5Ah 18V Li-Ion – 3.0Ah 18V Li-Ion – 4.0Ah 18V Li-Ion – 5.0Ah 18V Li-Ion – 6.0Ah
	DC18SD DC18RC DC18RD DC18SE	Chargers 18vV Standard 240V Charger 18V Rapid 240V Charger 18V Dual Port Rapid 240V Charger 18V Automotive 12-24V Charger

Optional Equipment		
	P-76788 P-76825 P-76825	Pro-Series Nylon Line 2.4mm x 15m 2.4mm x 44m 2.4mm x 87mm
	369.224.602 369.224.603 369.224.604	Contractor Series Nylon Line 2.4mm x 15m 2.4mm x 87m 2.4mm x 262m
	369.224.071 369.224.070 369.224.072	Elite Silent Nylon Line 2.4mm x 3.5m 2.4mm x 15m 2.4mm x 120m
	197188-6 197189-4	255mm Retractable Tri Blade Plastic Head Plastic Blade replacements 12Pk
	196745-7	Cutter Blade Part
	511.291.739 6013089400	Chain 10" 3/8 0.043 C/L39 Bar 10" 0.043